

# LED Highbay Light

## HBL-02-G4



### Better solutions for a Led Highbay Light

- IP65 water-proof
- AC100-277V 50/60Hz
- Easy Installation
- 140Lm/w

### Options

Power	Color	Beam Angle
MEAN WELL DRIVER	3000K	60°
HBG series B: Dimmable 1-10V	4000K	90°
HBG series AB	5700K	120°
ELG series A: Standard		
ELG series B: Dimmable 0-10V		
ELG series DA: Dimmable DALI		



### Application

Factories, Steel Mills, Steel Smelting Plants, Manufacturing Plants & Warehouses  
 Farms and Industrial Installations, sport Facilities & Workshops, Storage Facilities & Warehouses  
 Supermarkets & Department Stores, Showrooms, Design Centers & Galleries.

### Specifications

Item	Power	Lumen	Leds	CRI	Weight	Beam Angle
BR-HBL80W-02-G4	80W	11200Lm	LUMILEDS 3030	> 80	3.50kg	60°/90°/120°
BR-HBL100W-02-G4	100W	14000Lm	LUMILEDS 3030	> 80	3.50kg	60°/90°/120°
BR-HBL120W-02-G4	120W	16800Lm	LUMILEDS 3030	> 80	3.50kg	60°/90°/120°
BR-HBL150W-02-G4	150W	21000Lm	LUMILEDS 3030	> 80	3.50kg	60°/90°/120°
BR-HBL200W-02-G4	200W	28000Lm	LUMILEDS 3030	> 80	5.50kg	60°/90°/120°
BR-HBL240W-02-G4	240W	33600Lm	LUMILEDS 3030	> 80	5.50kg	60°/90°/120°

### Dimensions(mm)

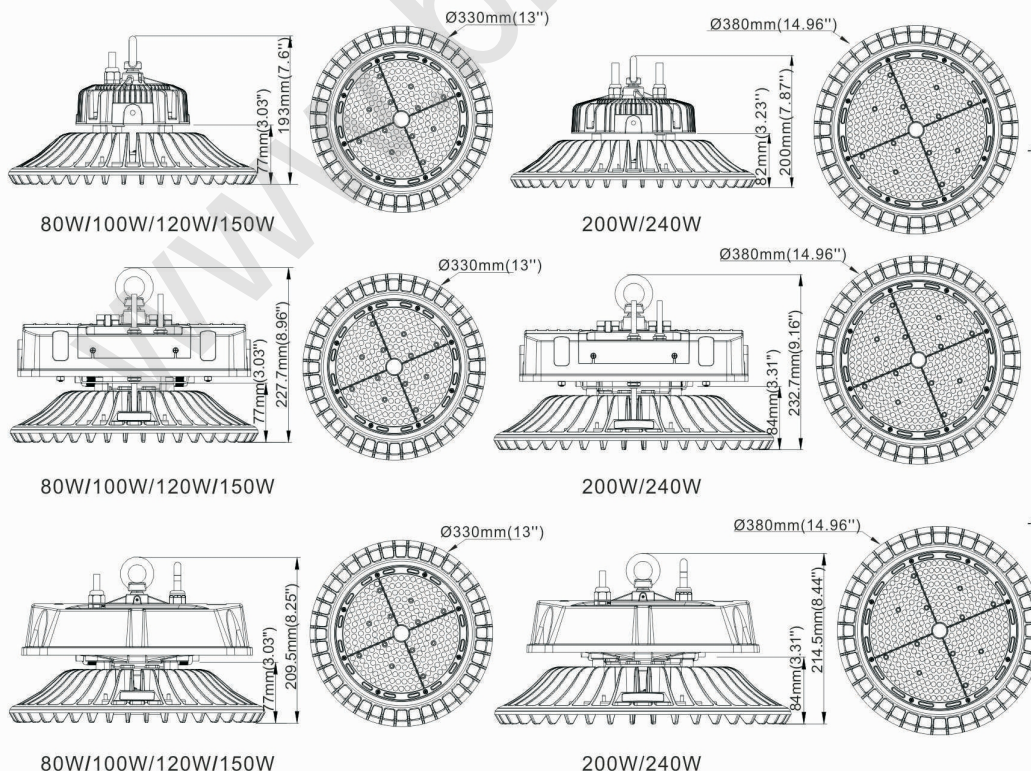

### Photometry

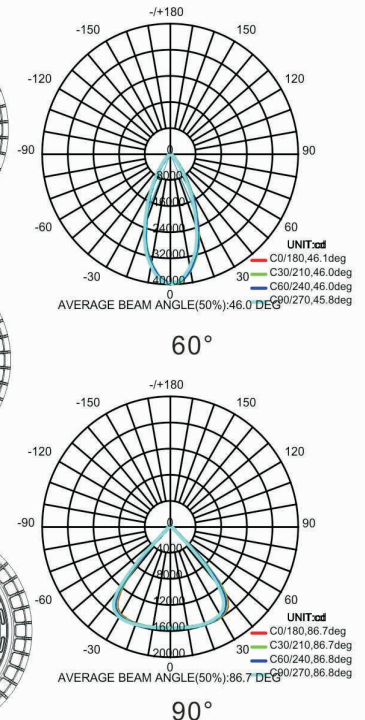

# HBL-02-G4



## Model Options



## Installation and use

### P1 Mounting Ring (Standard)

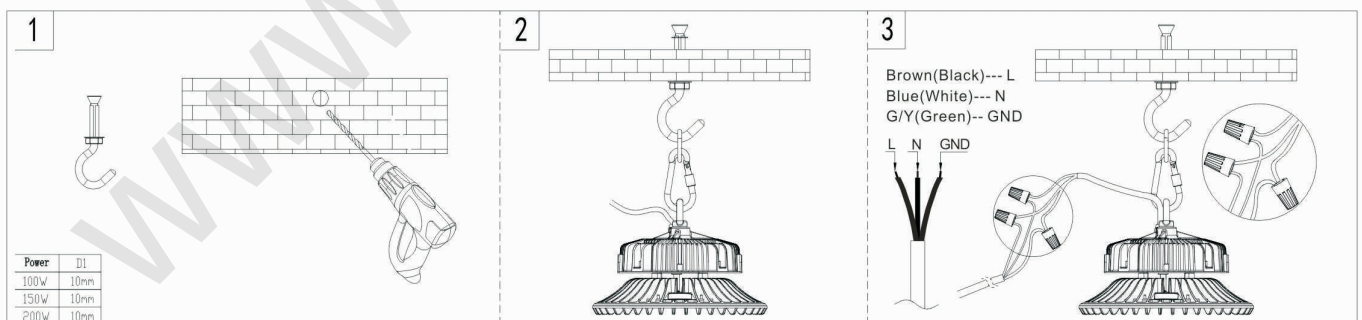

### P2 Mounting Bracket A

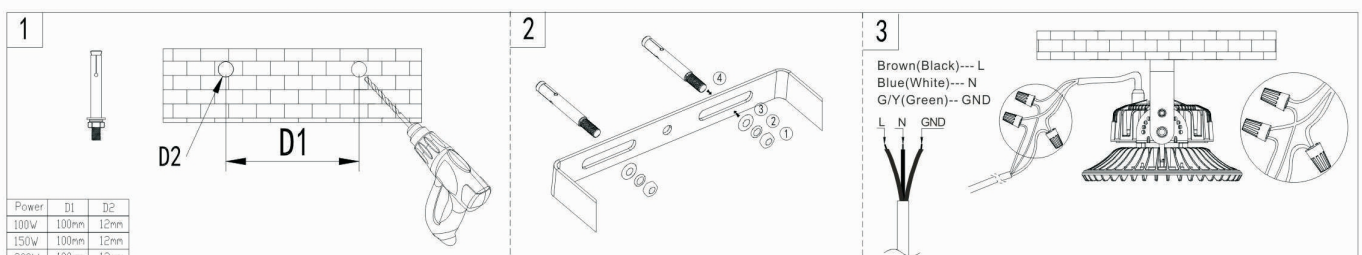

# HBL-02-G4 LED Highbay Lights

## P3 Mounting Ring

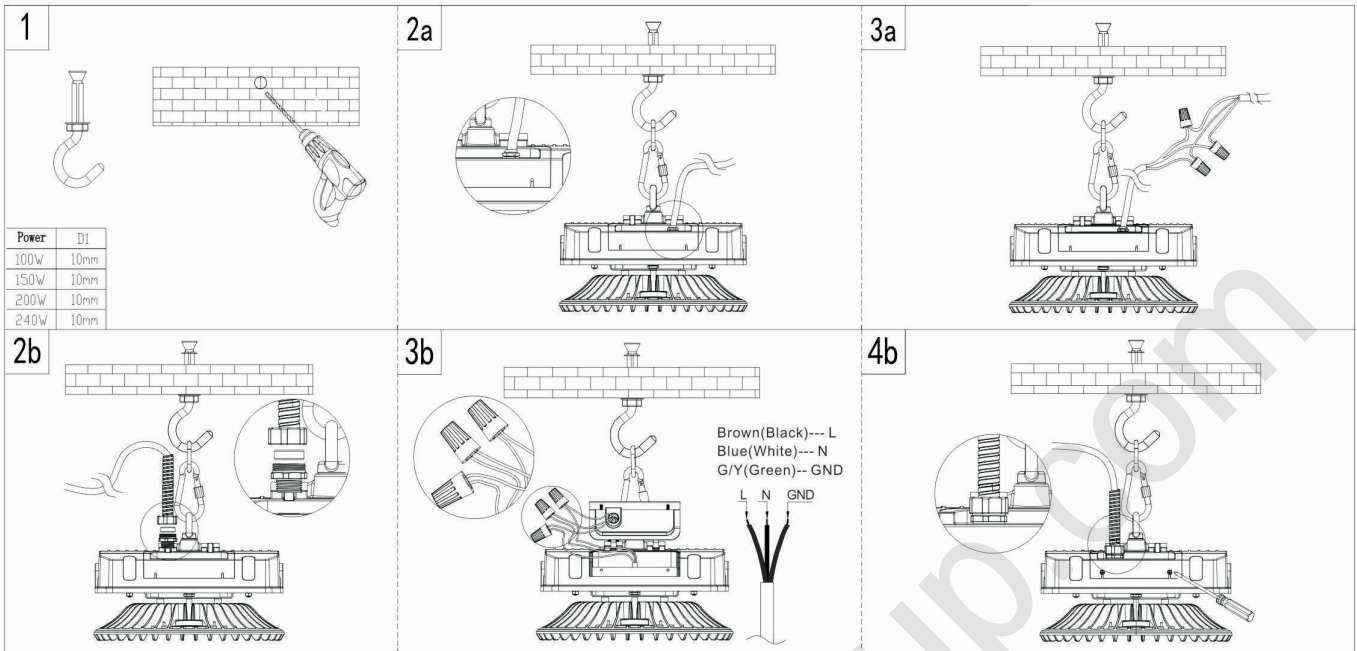

## P4 Mounting Bracket B

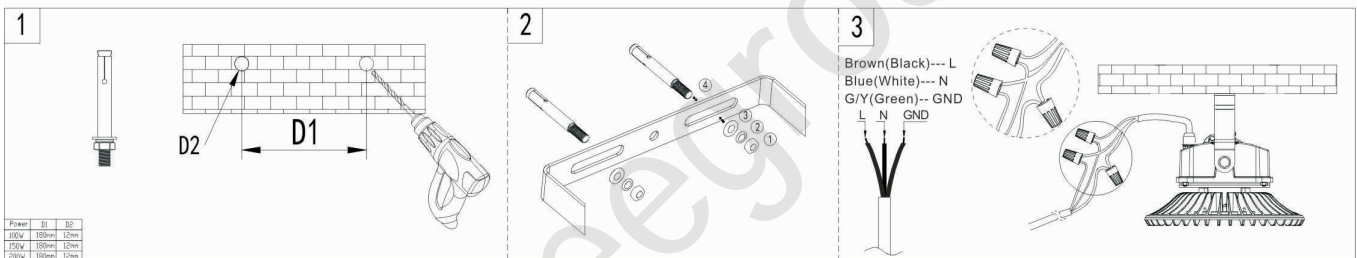

## P5 Mounting Ring

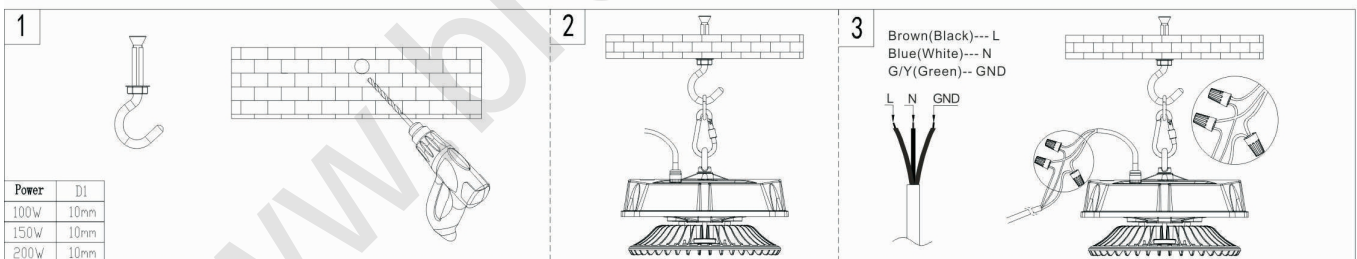

## P6 Mounting Bracket C

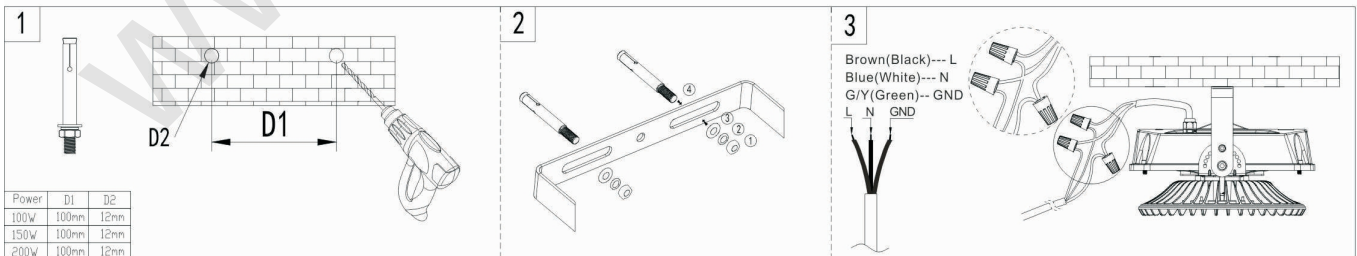

## Packing Spec

Item	Box			Carton		
	Measurement(mm)	Gross weight	Pcs/box	Measurement(mm)	Gross weight	Pcs/box
BR-HBL80W/100W-02-G4	L415*W415*H290	5.12kg	1	/	/	/
BR-HBL120W/150W-02-G4	L415*W415*H290	5.12kg	1	/	/	/
BR-HBL200W/240W-02-G4	L465*W465*H310	7.68kg	1	/	/	/